

For reference only. See data sheet for the detailed specifications.

## Technical Specification

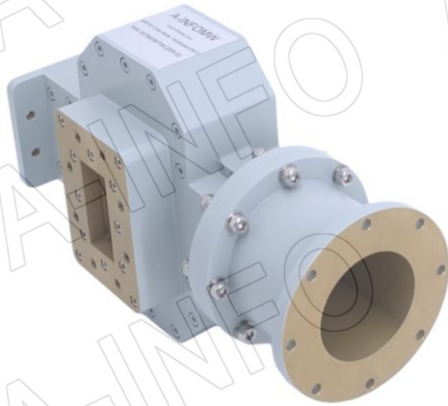

EIA WR	WR187
Frequency Range(GHz)	3.95 – 5.85
Bandwidth	Full
Common Port	51.99mm / 2.05" Circular WG
Insertion Loss(dB)	0.5 Max.
VSWR	1.30:1 Typ.
Cross Pol. Isolation(dB)	60 Typ.; 50 Min.
Port to Port Isolation(dB)	50 Min.
Common Port Flange	FAP48-M(UAR48-M)
Flange	FDP48(UDR48) (Modified with 8xM6 Deep7)
Material	Al
Size(mm)	233.7 x 95.6 x 152.4
Net Weight(Kg)	2.29 Around

## Outline Drawing (Size: mm)

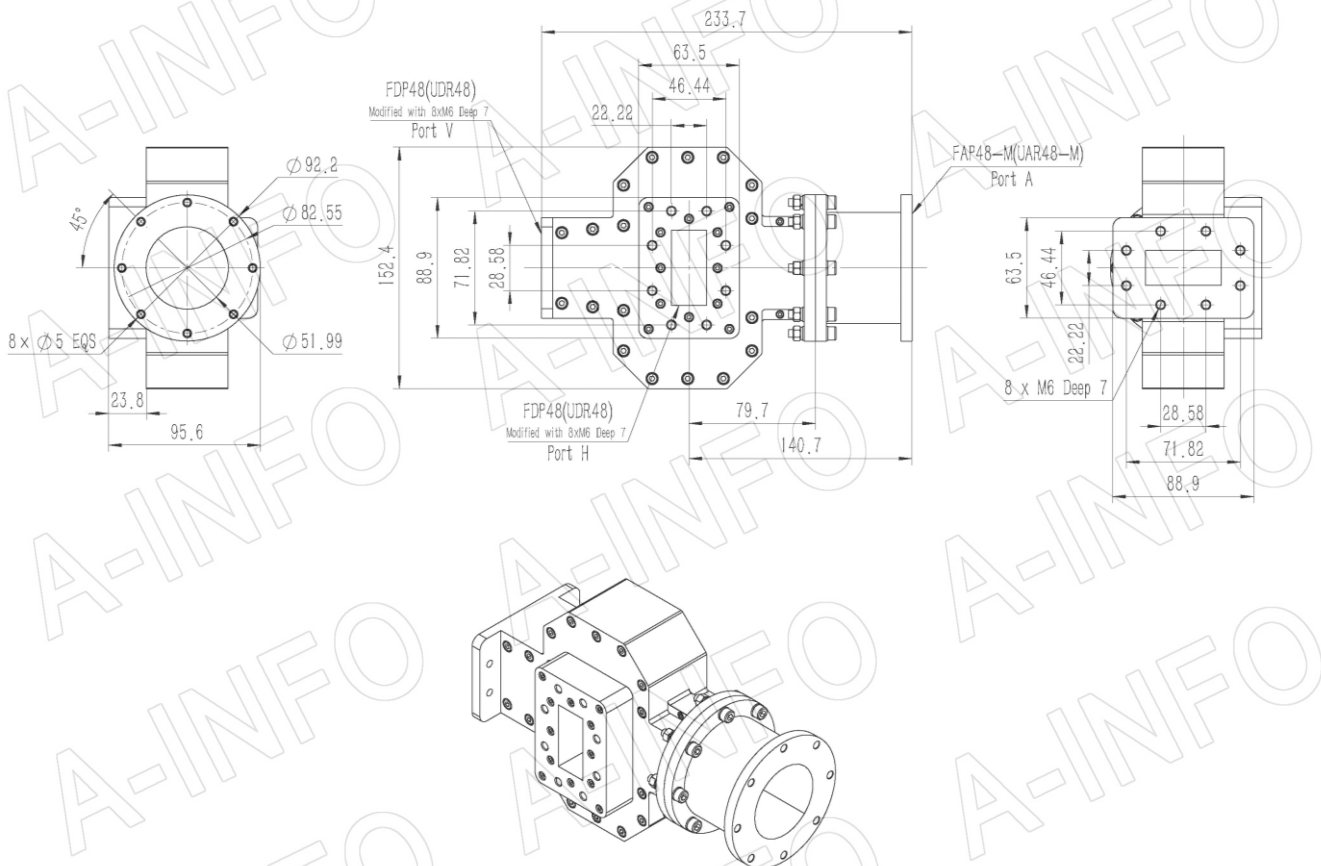

**AINFO Inc.**

China(Beijing): Tel: (+86) 10-6266-7326,  
China(Chengdu): Tel: (+86) 28-8519-2786,  
USA: Tel: (+1) 949-639-9688,

Page 1 of 5

(+86) 10-6266-7327 Fax: (+86) 10-6266-7379  
(+86) 28-8519-3044 Fax: (+86) 28-8519-3068  
(+1) 949-639-9608 Fax: (+1) 949-639-9670

Website: [www.ainfoinc.com](http://www.ainfoinc.com)  
Email: [sales@ainfoinc.com](mailto:sales@ainfoinc.com)

## Flange Drawing (Size: mm)

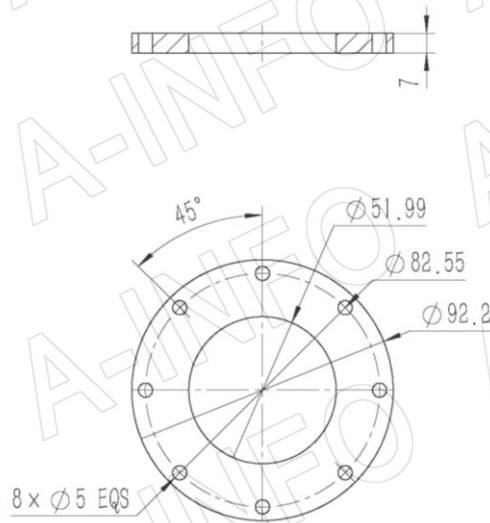

FAP48-M

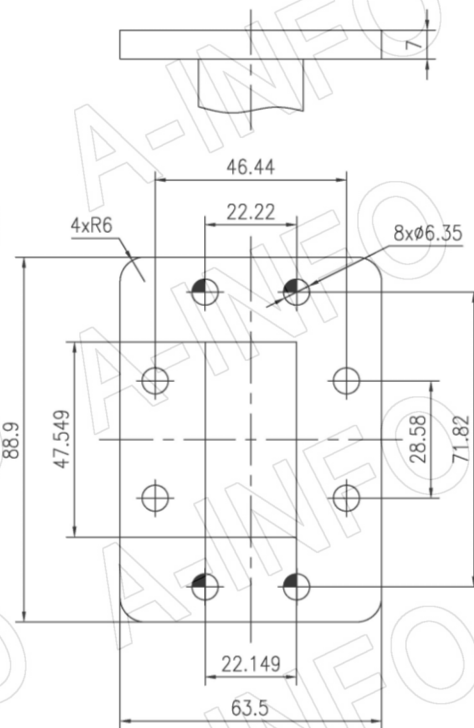

FDP48

**AINFO Inc.**

China(Beijing): Tel: (+86) 10-6266-7326,  
 China(Chengdu): Tel: (+86) 28-8519-2786,  
 USA: Tel: (+1) 949-639-9688,

Page 2 of 5

(+86) 10-6266-7327 Fax: (+86) 10-6266-7379  
 (+86) 28-8519-3044 Fax: (+86) 28-8519-3068  
 (+1) 949-639-9608 Fax: (+1) 949-639-9670

Website: [www.ainfoinc.com](http://www.ainfoinc.com)  
 Email: [sales@ainfoinc.com](mailto:sales@ainfoinc.com)

## Test Results

### Port H\_ Insertion Loss(Test with two OMT back to back)

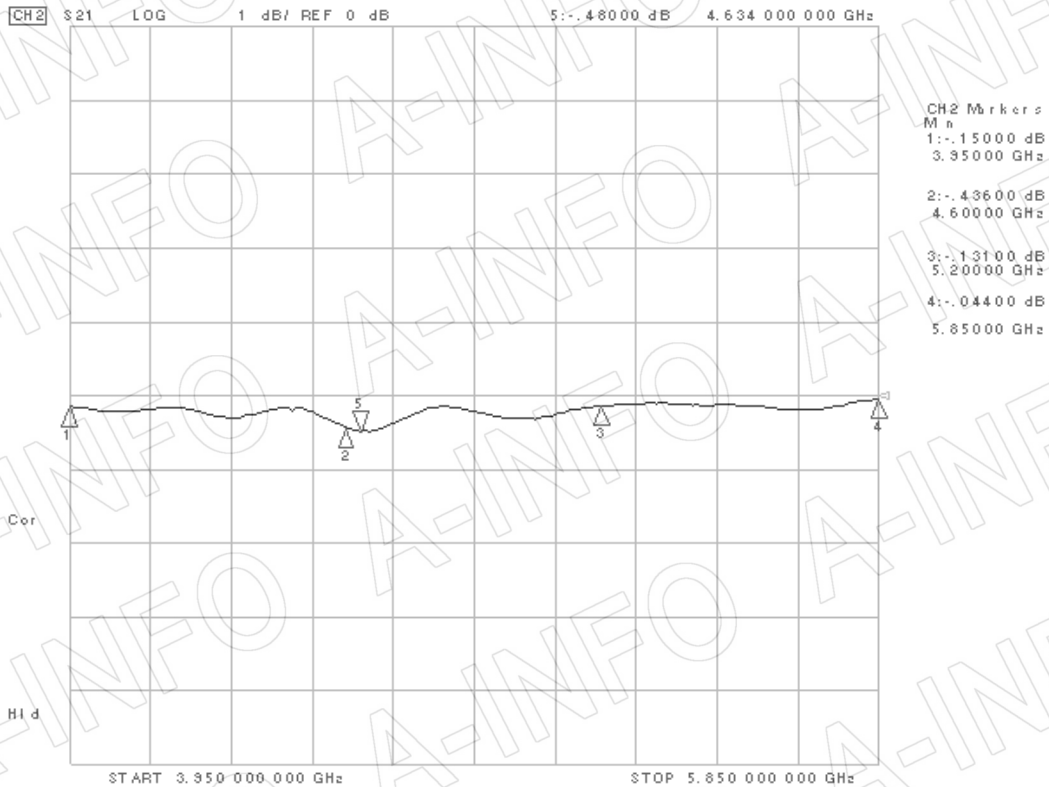

### Port V\_ Insertion Loss(Test with two OMT back to back)

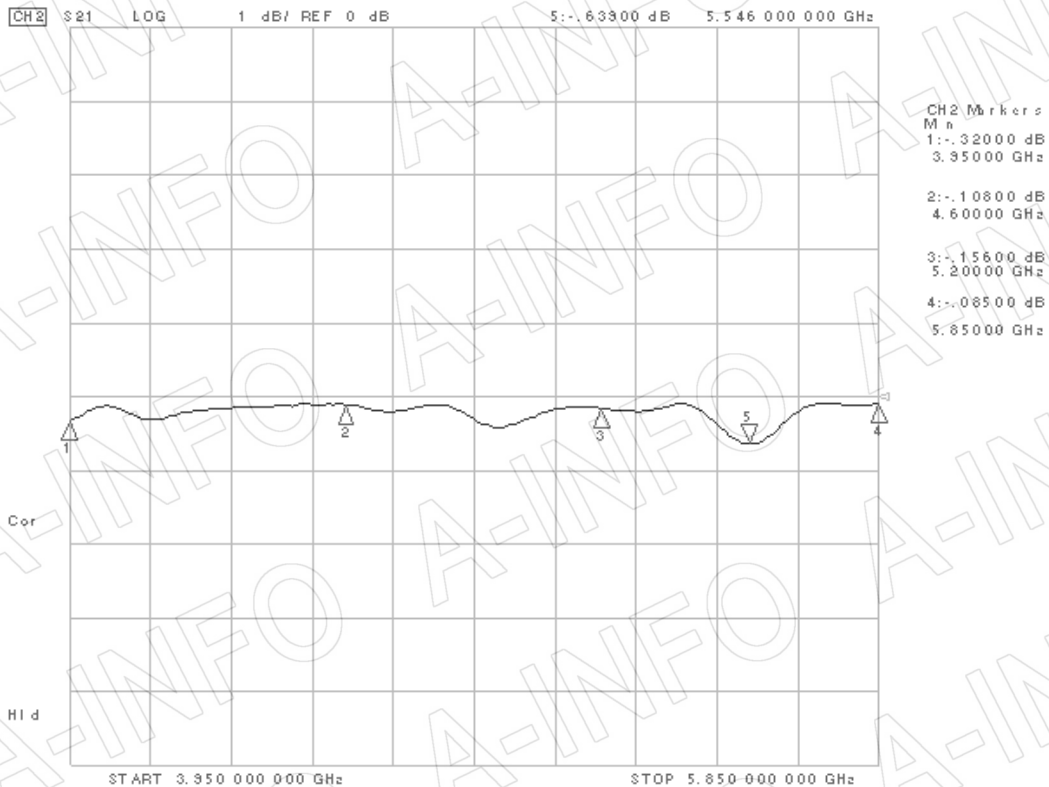

### Port H\_VSWR

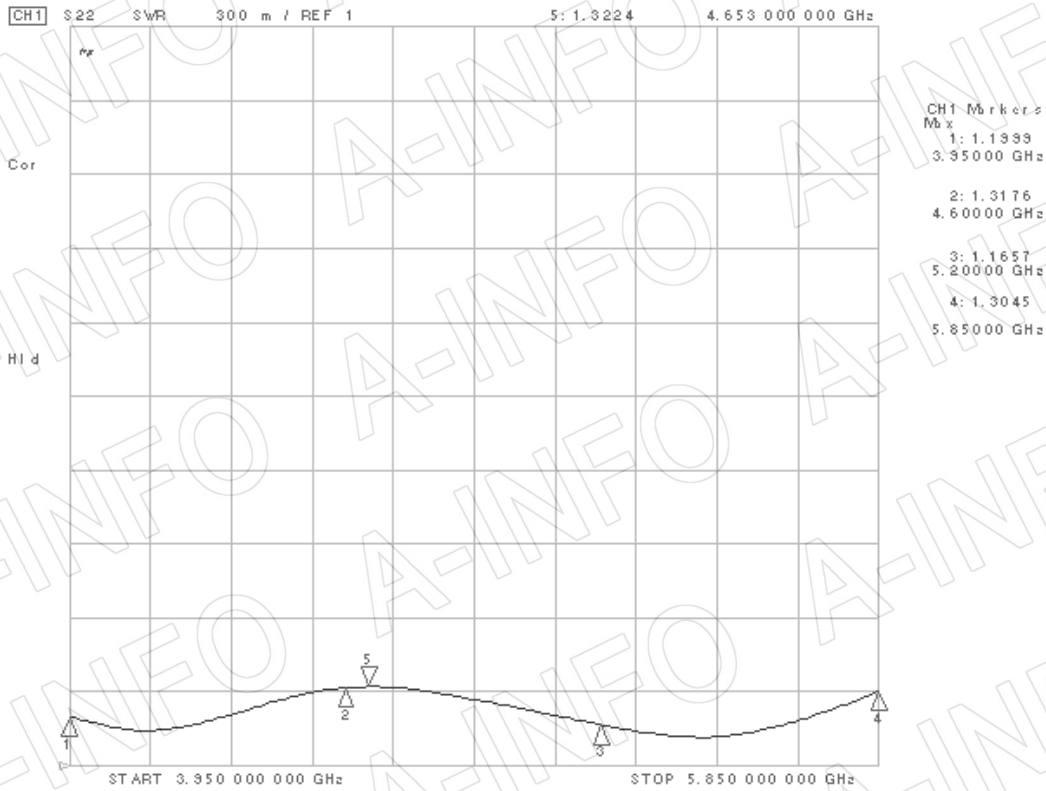

### Port V\_VSWR

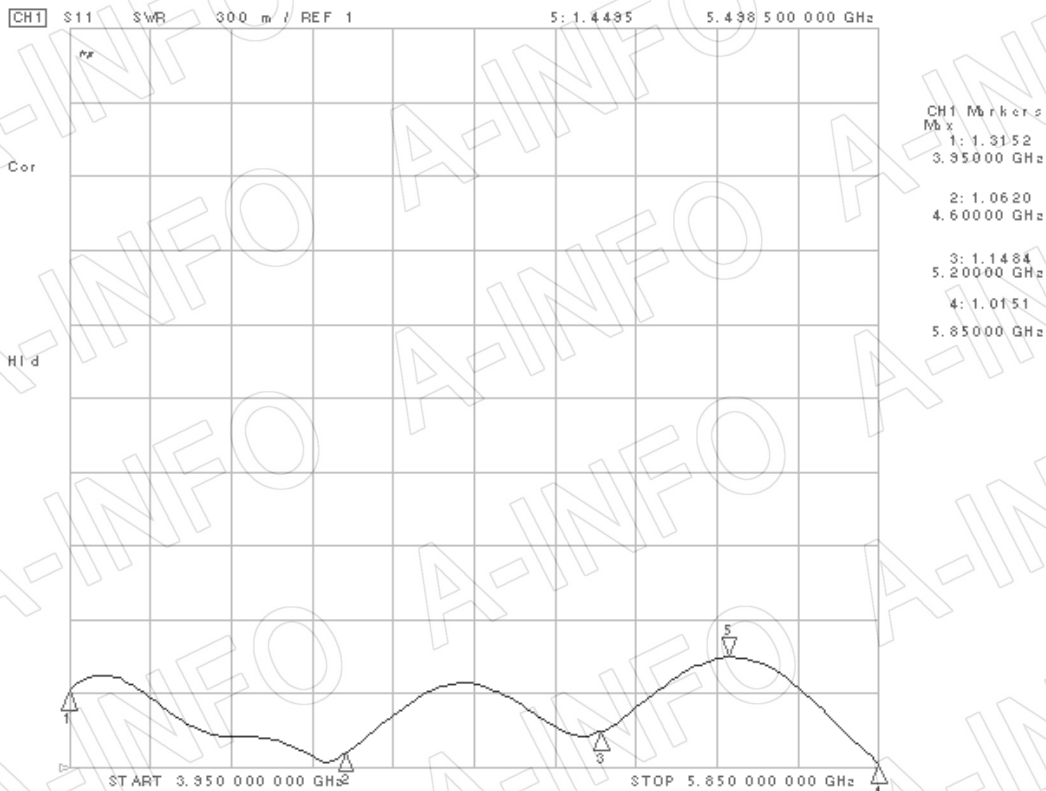

## Cross Polarization Isolation

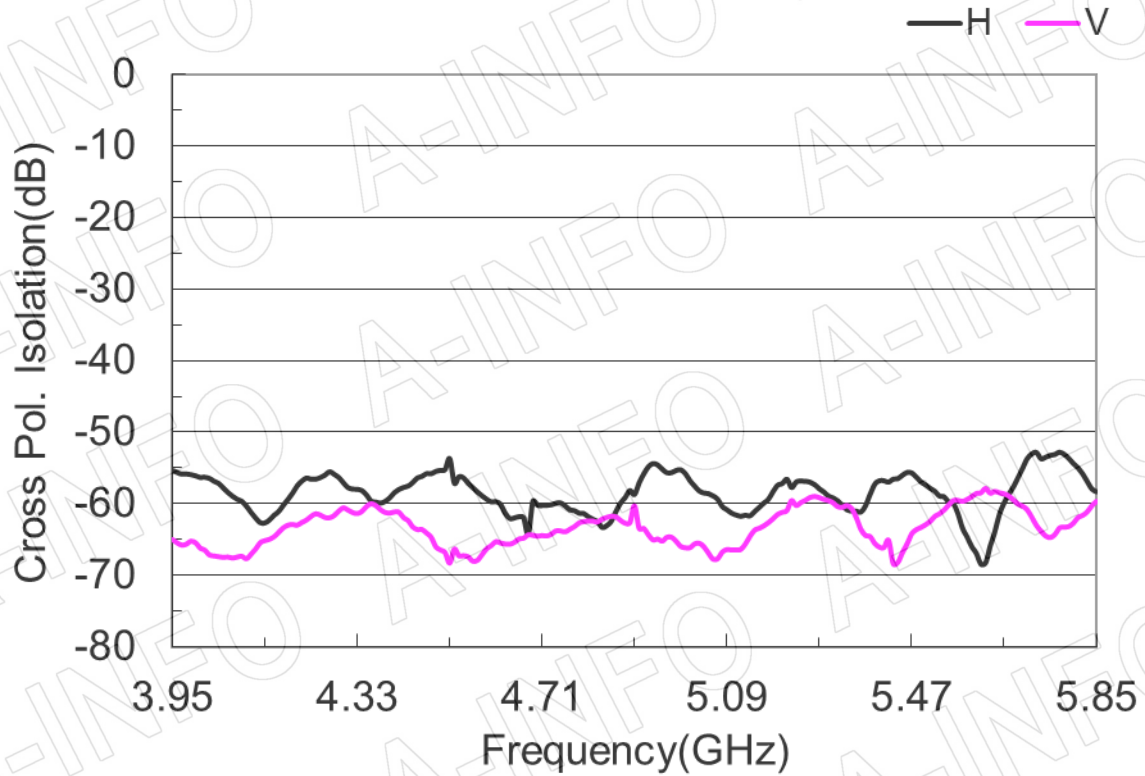

## Port to Port Isolation

